

WOR-BIZ DO WELL IN

Stamping

Precision CNC machining

Fabrication.

Material include: Various carbon steel, stainless steel, low alloy steel, Brass, Bronze, Stainless steel, Aluminum and Zinc.

WOR-BIZ MISSION

Supply directly and make supply more flexible!

PROFESSIONAL OEM SUPPLIER, 15 YEARS SUCCESSFUL DEVELOPMENT EXPERIENCE GUARANTEED.

PRODUCT APPLIED RANGE:

Transmission components

Engine and gears components

Industrial valves components

Automobile components

Agriculture machinery components

Water works valves and fittings.

Construction machinery components

R & D SERVICE:

Prototype sampling process

Design according to customer requirement

Optimization design based on target cost

QUALITY CONTROL:

Quick QC service in door

Skilled local engineer for daily QC in manufacturer

Customer-made QC file preparation

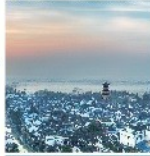

WOR-BIZ Industrial product Co., Ltd.

is a professional components OEM supplier for various territories.

Applied range include construction machinery, mechanical machinery, agriculture machinery, automobile, medical device etc.

WOR-BIZ located in HEFEI, CHINA.

We provide professional service to our customer not only products but also R&D support.

To save each penny and make design more reasonable for our customer is our mission in our whole business period.



WOR-BIZ INDUSTRIAL PRODUCT CO., LTD.

www.worbizind.com

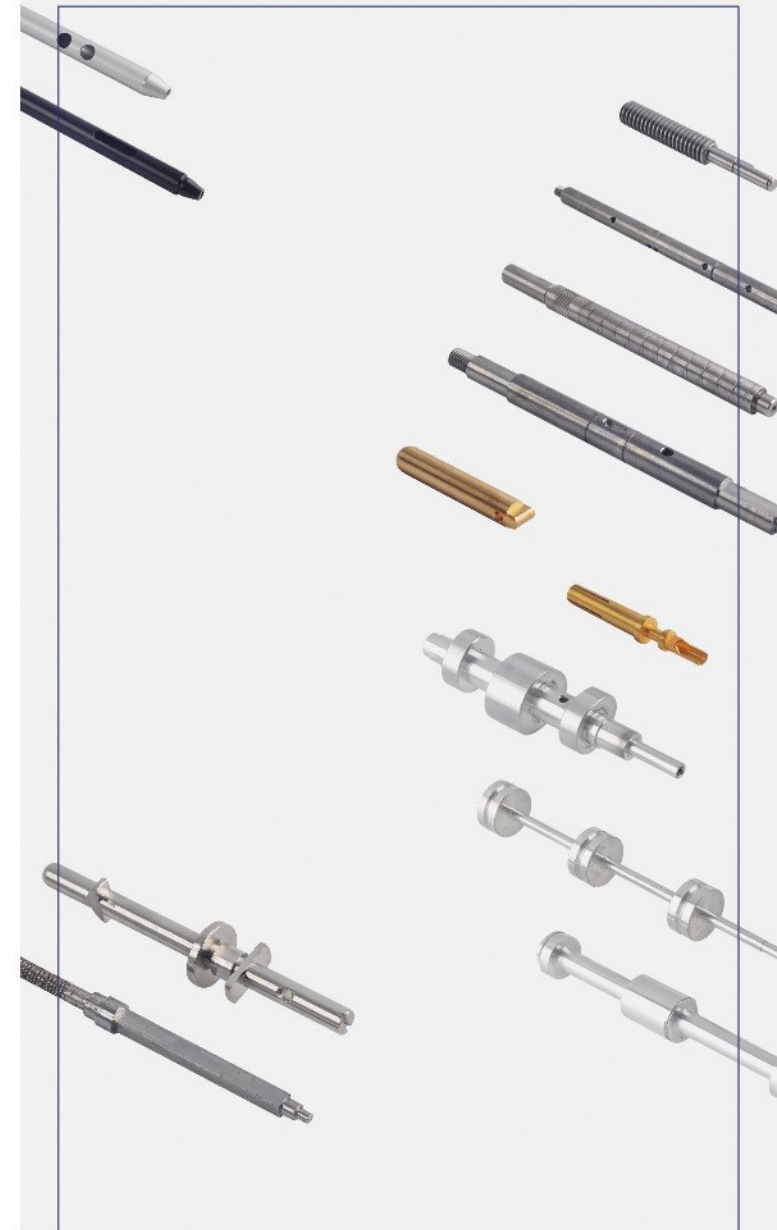

WOR-BIZ INDUSTRIAL PRODUCT CO., LTD.

STAMPING PARTS

Brackets/Support

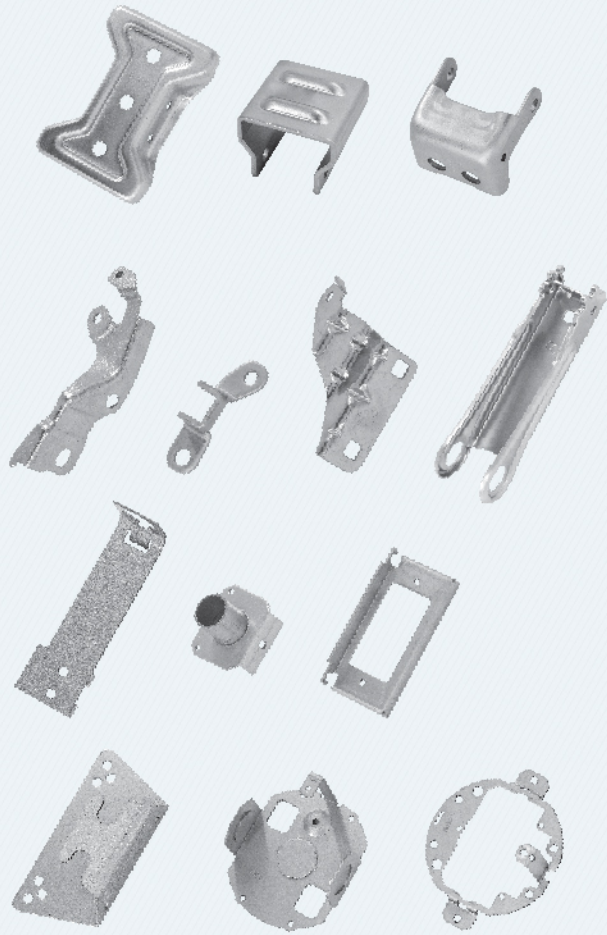

Electric adapter



Clamp

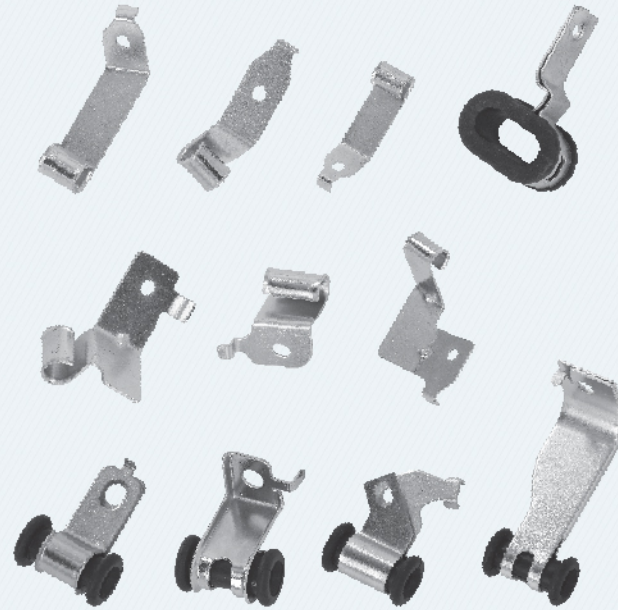

Fixture plat

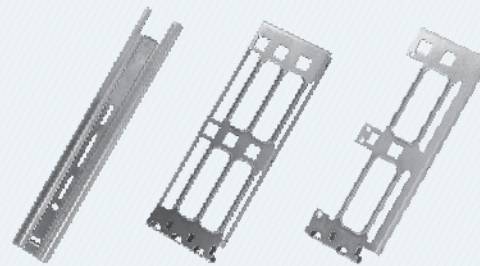

Decoration part



PRECISION CNC MACHINING PARTS

Shaft



Valve components



Electric product parts



STAMPING PARTS

BRACKETS/SUPPORT



STAMPING PARTS

CLAMP



STAMPING PARTS

ELECTIC ADAPTER

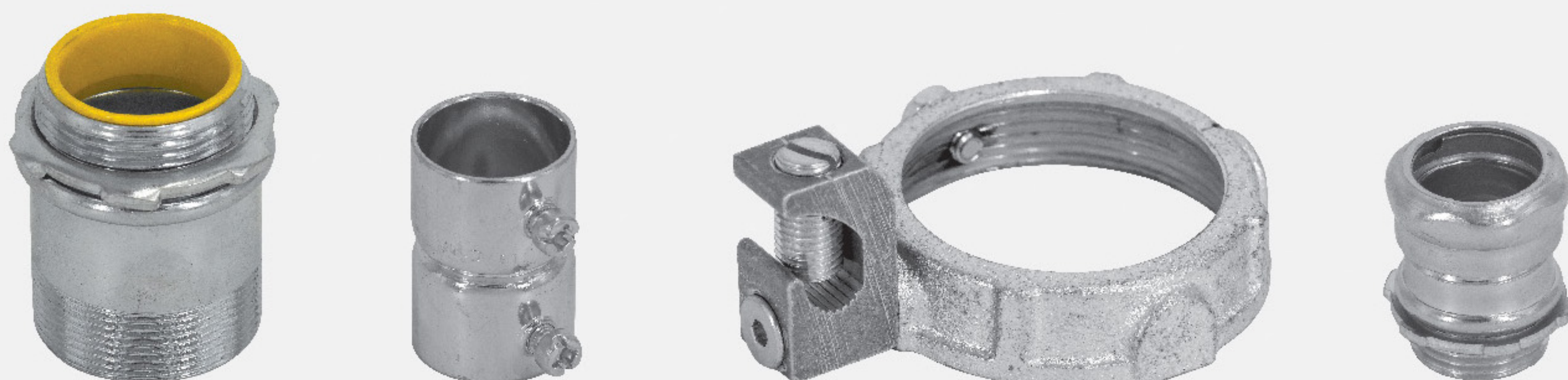

FIXTURE PLAT

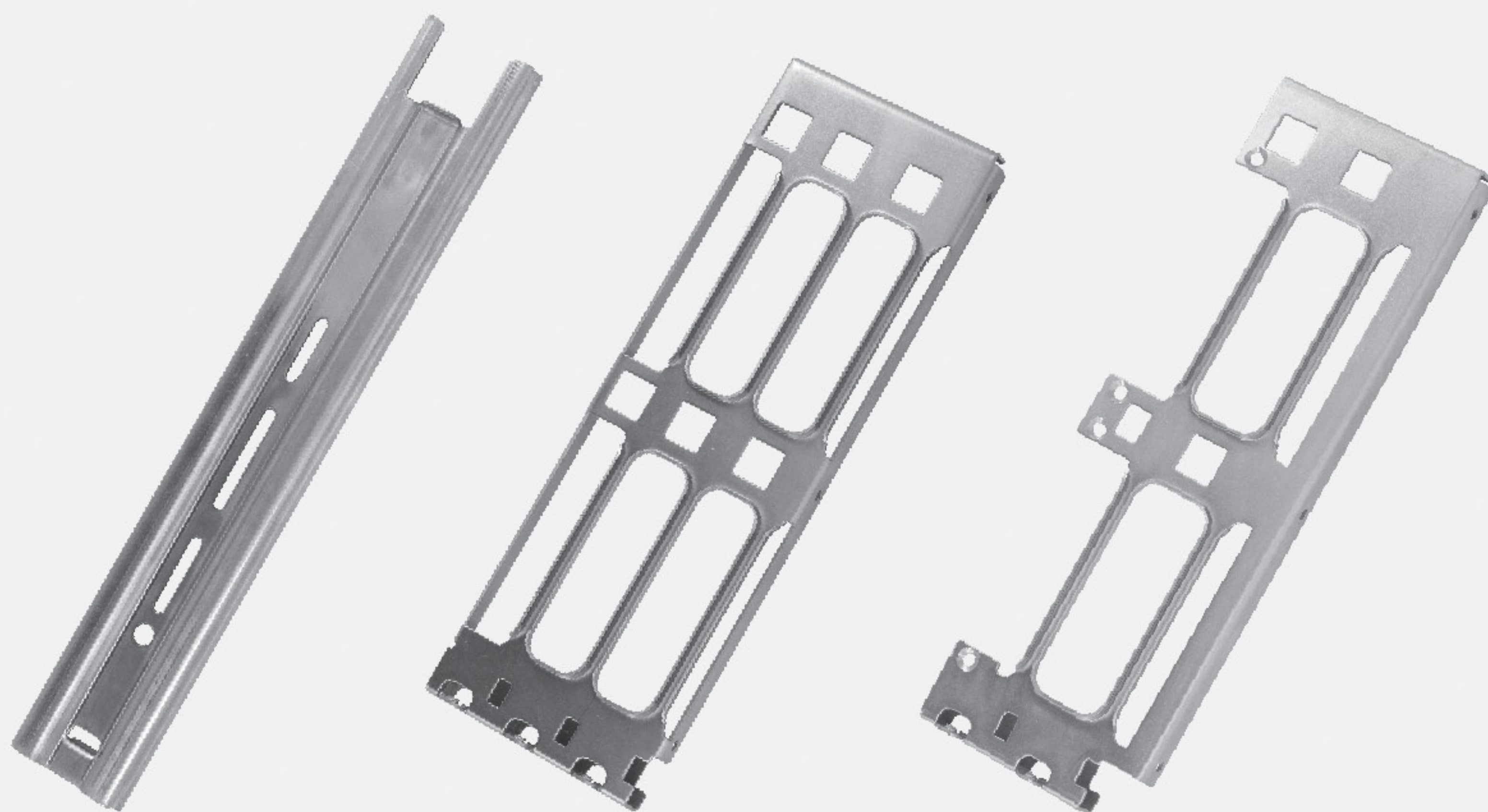

DECORATION PART



PRECISION CNC MACHINING PARTS

SHAFT



VALVE COMPONENTS



ELECTRIC PRODUCT PARTS





WOR-BIZ Industrial product Co., Ltd.
is a professional components OEM supplier for various territories.
Applied range include construction machinery,
mechanical machinery, agriculture machinery,
automobile, medical device etc.

WOR-BIZ located in HEFEI, CHINA.
We provide professional service to our customer not only
products but also R&D support.
To save each penny and make design more reasonable
for our customer is our mission in our whole business period.



WOR-BIZ INDUSTRIAL PRODUCT CO., LTD.

